





Thermal Integration in Sugar Production Using Pinch Analysis

Integración térmica en la producción de azúcar mediante análisis del pellizco

Juan R. Vidal Medina¹  Andrés F. Rodríguez Valencia¹   Julián Pérez Marin²
Yuri U. López Castrillón¹ 

¹Profesor Titular, Universidad Autónoma de Occidente, Cali, Colombia.

²Ingenio del Cauca, Caloto, El Ortigal, Cauca, Colombia.

Abstract

Objective: the objective of this study is to conceptualize a network of heat exchangers designed to minimize energy waste and enhance the overall efficiency of the sugar production system.

Methods: a systematic approach was adopted to analyze energy flows within the plant, identifying key areas for improvement, particularly in heating and evaporation processes. Heat accumulations in cascades and graphical analyses of composite curves were developed using specialized software to optimize heat exchange.

Results: the results indicate a significant potential for energy savings, reducing the consumption of cooling and heating utilities in the plant by 7% and 30%, respectively. The developed computational tool allows for energy integration from simple processes to those with hundreds of streams. The pinch technology concept estimated an annual total savings of \$464,850.08 in the selected process.

Conclusion: this study demonstrates that thermal integration through pinch analysis not only improves energy efficiency in the sugar industry but also contributes to a considerable reduction in operational costs and environmental impact, providing a valuable tool for the industry's sustainability and competitiveness.

Keywords: Computational tool, thermal integration, system identification, energy savings, Pinch methodology

Resumen

Objetivo: el objetivo de este estudio es conceptualizar una red de intercambiadores de calor diseñada para minimizar el desperdicio de energía y mejorar la eficiencia global del sistema en la producción de azúcar.

Metodología: se adoptó un enfoque sistemático para analizar los flujos de energía dentro de la planta, identificando áreas clave de mejora, especialmente en los procesos de calentamiento y evaporación. Se desarrollaron acumulaciones de calor en cascada y análisis gráficos de curvas compuestas utilizando software especializado para optimizar el intercambio de calor.

Resultados: Los resultados indican un potencial de ahorro energético significativo, reduciendo el consumo de servicios públicos de frío y calor en la planta en un 7% y un 30%, respectivamente. La herramienta computacional desarrollada permite realizar integraciones energéticas desde procesos simples hasta aquellos con cientos de corrientes. El concepto de tecnología Pinch estimó un ahorro anual total de 464.850,08 USD en el proceso elegido.

Conclusiones: este estudio demuestra que la integración térmica mediante el análisis del pellizco no solo mejora la eficiencia energética en la industria azucarera, sino que también contribuye a una reducción considerable de costos operativos y al impacto ambiental, ofreciendo una herramienta valiosa para la sostenibilidad y competitividad de la industria.

Palabras clave: Herramienta computacional, integración térmica, identificación de sistemas, ahorro energético, metodología Pinch.

How to cite?

Vidal, J.R., Rodríguez, A.F., Pérez, J., López, Y.U. Thermal Integration in Sugar Production Using Pinch Analysis. Ingeniería y Competitividad, 2024, 26(3)e-21114315

<https://doi.org/10.25100/iyv.v26i3.14315>

Recibido: 03-07-24

Evaluado: 13-08-24

Aceptado: 16-09-24

Online: 9-10-24

Correspondence

afrodriguezv@uao.edu.co



CrossMark



Why was it carried out?

The study was carried out to tackle the significant challenges of energy consumption and operational costs faced by the sugar production industry, particularly in the context of rising energy prices and increasing environmental concerns. The research aimed to implement the Pinch methodology as a systematic approach to optimize heat recovery and improve energy efficiency within the cane sugar production process. By identifying key areas for improvement in energy flows and developing effective strategies for thermal integration, the study sought to enhance the sustainability of the production process while simultaneously reducing costs. This initiative was crucial for the industry, which often experiences high energy demands and substantial thermal losses, thereby necessitating innovative solutions to improve overall competitiveness and reduce environmental impact.

What were the most relevant results?

The most relevant results of the study highlighted significant potential for energy savings and economic benefits in the sugar production process through the application of the Pinch methodology. Specifically, the research indicated an estimated reduction of 7% in hot utility consumption and 30% in cold utility consumption, translating to projected annual savings of approximately 461,892 USD in utility costs. Additionally, the development of a specialized computer program, Delta Pinch, facilitated the analysis and optimization of thermal processes, allowing for efficient energy integration across various operational scenarios. This tool not only reduced analysis times when comparing different temperature differences (ΔT_{min}) but also enabled the design of an effective heat exchange network. Furthermore, the economic analysis revealed that implementing the Pinch methodology could yield substantial cost savings, with an initial investment of 439,601.60 USD for a heat exchange area of 1.483 m², underscoring the methodology's potential to enhance the economic viability and sustainability of sugar production.

What do these results contribute?

The results of the study contribute significantly to both the sustainability and economic viability of the sugar production industry by demonstrating effective strategies for energy optimization and resource management. By showcasing the potential for substantial energy savings and reduced operational costs, the findings underscore the importance of implementing the Pinch methodology as a means to enhance energy efficiency and minimize environmental impact. This not only positions sugar production as a more competitive sector in an increasingly sustainability-focused market but also provides a practical framework for other industries facing similar energy challenges. Additionally, the development of the Delta Pinch program represents a valuable tool for engineers and industry professionals, enabling them to analyze and optimize thermal processes more effectively. Overall, these contributions pave the way for ongoing improvements in energy management practices, fostering a shift towards more sustainable production methods and reinforcing the industry's commitment to reducing its carbon footprint.

Graphical Abstract

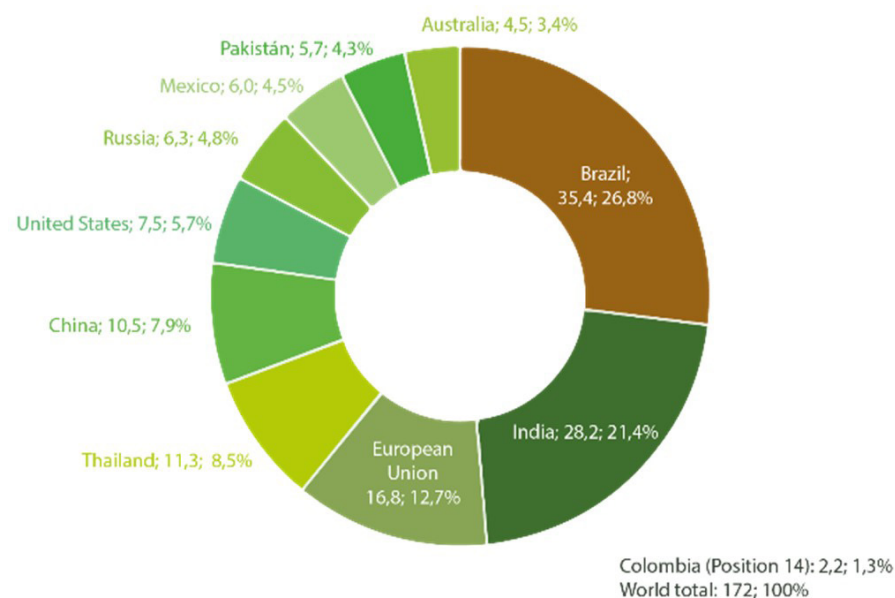



Introduction

The production of sugar and ethanol from sugar cane is one of the main activities in Valle del Cauca - Colombia, and one of the most critical sectors of the national economy (1). Based on data reported by the International Sugar Organization (OIA), taking an average between 2016 and 2020, Colombia continues to rank as the 15 largest sugar producers and exporters among 110 global producers and 115 exporters. On average, between 2016 and 2020, according to figures from the International Sugar Organization (IOA), Colombia ranked 14th among the most significant world producers, but with a share of only 1.3% of world production, which is equivalent to an average of 2.6 million tons of sugar and alcohol equivalent produced from 2012 to 2021 (2). Also, according to these data presented by OIA, it is evident that Brazil is one of the largest sugar producers in South America, with a share of 26.8% of world production. In (3), different studies are presented to show alternatives to improve the industrial production process of sugar cane in Brazil. The study on improving bioethanol production through thermal integration reveals significant advancements in energy efficiency and cost reduction. By integrating rectification and distillation columns, the process achieves substantial energy savings, notably reducing steam demand compared to traditional distillation methods. The application of Pinch Technology further optimizes utility requirements, enhancing the overall energy consumption profile and increasing the availability of sugarcane bagasse for alternative uses. Additionally, the evaluation of various cogeneration systems demonstrates that optimized thermal integration can improve the performance of these systems, enabling the sale of surplus electricity to the grid and bolstering the economic viability of bioethanol production (4). The main findings of the study on improving second generation bioethanol production in sugarcane biorefineries through energy integration highlight the significant potential of using Pinch analysis for optimizing energy consumption. The research demonstrated that energy integrated processes can achieve a reduction in energy consumption of over 50% compared to scenarios without energy integration, and more than 30% compared to processes with project integration typically found in Brazilian industrial plants. This optimization not only enhances the economic viability of second generation ethanol production by decreasing utility costs but also increases the availability of bagasse for ethanol production, thereby contributing to a more sustainable and efficient biorefinery operation (5). Dias et al. (6) utilize pinch analysis to optimize thermal integration in the bioethanol production plant by identifying the minimum requirements for external hot and cold utilities and maximizing heat recovery from process streams. Through simulations, it was determined that using a double-effect distillation system allows for 90% of the sugarcane bagasse to be available for hydrolysis, compared to 76% with a conventional system. This integration leads to a 26% increase in bioethanol production while effectively reducing energy consumption.

Sugar plants that sell surplus electrical energy or ethanol have a high potential for improving energy performance through heat integration according to (7). The Pinch methodology is a thermal energy recovery technique developed in response to the 1970s oil crisis, evolving as an optimization and design tool for heat exchange networks (8). The objective of the Pinch methodology is the energy integration of processes to increase energy efficiency and the use of energy from the process streams, reducing heat consumption and the demand for cooling systems. The Pinch methodology has been implemented in industrial operations worldwide, resulting in significant energy and capital efficiency improvements; most efforts with this methodology focus on determining optimal

external load consumption, minimizing waste heat discharge, and producing sustainable energy according to [\(9\)](#)[\(10\)](#).

The fundamental principles of the Pinch methodology are used to develop and enhance the design of chemical processes. Specifically, this method was applied in the sugar production process [\(1\)](#) and J. Carrillo presents the results of applying the Pinch methodology to the energy integration of the anhydrous alcohol production process in a sugar mill. This application generated alternatives that allow an 8.5% reduction in costs associated with steam consumption in boilers and the use of cooling water in the process [\(11\)](#). This methodology was implemented in the Cartagena Refinery, Colombia's Catalytic Breakdown Unit, to assess various separation processes [\(12\)](#). The analysis determined that an investment of 143,453.28 USD in the liquor process and 20,993 USD in the alcohol process was necessary to ensure the retrofit identified through the utilization of the Pinch methodology. This retrofit would result in annual savings of 22,624.66 USD and 196,897.20 USD respectively.

Moreover, when applying the Pinch methodology to a multi-effect evaporation tandem, the energy recovery is maximized when vapor extraction for other purposes occurs in the last effects, characterized by lower pressure vapors according to [\(13\)](#). Moreover, through the analysis of the combined sugar and ethanol production process using the Pinch methodology, adjustments to the operating parameters of the evaporation station were identified as a means to reduce heat demand in correspondence with [\(14\)](#). Furthermore, a study evaluated the production parameters for different sugarcane plant configurations, including scenarios where all sugarcane juice is utilized for ethanol production without sugar production, this by [\(15\)](#).

A. Ensinas and S. Nebra's study on thermoeconomic optimization in sugar cane factories reveals significant findings regarding cost efficiency and energy consumption. The optimization procedure led to a notable reduction in total costs across various sub-systems, particularly achieving a 33.6% savings in the evaporation system, which accounted for 73.8% of the overall cost reduction. The research demonstrated that utilizing vapor bleeds from later evaporation effects decreased the demand for exhausted steam, allowing the system to evaporate the same amount of water with 16% less energy [\(16\)](#). Lastly, a Pinch analysis conducted on a sugar factory revealed the potential for a 9% reduction in thermal demand by optimizing the evaporation area by substituting a quadruple effect with a quintuple impact [\(17\)](#).

Pinch technology obtains economic benefits in various other industry sectors by employing energy savings. For instance, a study determined the return on investment period of a polyurethane production process of a petrochemical plant in 2.3 years in accordance with [\(18\)](#). Likewise, in the evaporation station of a paper pulp plant in Switzerland, the implementation of Pinch technology allowed the modification of operating conditions, thereby reducing the required temperature differential and pressures in the evaporation effects. Consequently, thermal energy consumption is reduced by 20%, this can be verified in [\(19\)](#). Similarly, an analysis conducted on an atmospheric distillation column revealed that auxiliary services account for over 80% of the section's energy consumption [\(20\)](#). Integrating preheating with a network of heat exchangers in the distillation section through changes in the system's operating conditions was enhanced using the Pinch methodology. This proposal led to a reduction in power demand in the distillation furnace

by 9,855 kW, which is equivalent to 820,000 USD per year according to (21). An analysis of freshwater usage and wastewater discharge in a sugar manufacturing process is presented in (22). Lastly, applying the Pinch methodology in the grinding area of a paper pulp mill resulted in an identified energy-saving potential of 18.5 MW, corresponding to approximately 12% of the current steam demand (8).

According to Robin Smith (23), key advancements in process integration since its inception include the expansion of applications beyond energy conservation to encompass raw materials efficiency, emissions reduction, and overall process operations. The integration of thermodynamic approaches with mathematical programming has allowed for more effective problem-solving. Additionally, the development of composite curves has improved the identification of heat recovery opportunities, while methodologies like the network pinch have facilitated the retrofitting of existing systems. B. Linnhoff, H. Dunford, and R. Smith (24) significantly advance the understanding of heat integration in distillation columns by emphasizing the necessity of considering these columns within the broader context of the overall process. Their work demonstrates that effective integration can lead to substantial energy savings, allowing distillation columns to operate at zero utility costs. They stress the importance of avoiding crossing the heat recovery pinch to achieve optimal integration and caution that traditional energy-saving methods may sometimes hinder this goal. By extending established principles of heat exchanger networks to distillation, the authors provide a valuable framework for enhancing energy efficiency in chemical processes. Heat Integration has significantly contributed to economic development and resource savings by enhancing energy utilization efficiency in industrial processes. According to J. Klemes and Z. Kravanja (25), the Process Integration (PI) methodology, which originated from Heat Integration, has provided systematic approaches to optimizing energy, water, and other resource usage. This optimization reduced operational costs and improved sustainability in the chemical, mechanical, and power engineering sectors. The main contribution of the investigation developed by P. Sabev Varbanov et al. (26) is the systematic review and analysis of Data Extraction (DE) practices in the context of Heat Integration (HI) and Total Site Analysis. The authors emphasize the complexity of data acquisition involving multiple stakeholders and the need for a common understanding of data semantics. They highlight the importance of preserving data integrity and documenting the reasoning behind data selection and exclusion. Additionally, the paper formulates a set of data requirements for DE, aiming to establish a standardized format that includes descriptors for the reasoning behind stream selections, thereby enhancing the quality and reliability of data used in HI processes.

The problem statement in this research focuses on the need to improve energy efficiency in cane sugar production, which often involves high energy consumption and significant thermal losses. The sugar industry faces sustainability and operating cost reduction challenges, which makes it imperative to find effective strategies to optimize energy use. The research question to be addressed is as follows: How can the Pinch methodology be implemented to reduce energy consumption in the cane sugar production process, maximize heat recovery, and minimize associated costs?

The main objective of this work is to develop a strategy to reduce energy consumption through the thermal integration of the cane sugar production process using the Pinch methodology. The research involves characterizing the current heat recovery system, proposing alternatives to improve energy efficiency, and designing a heat exchange

network that minimizes total costs. Firstly, developing a computer program named Delta Pinch is of notable significance and secondly, applying the Pinch methodology to the currents of a sugar manufacturing process is presented as a valuable contribution.

Methodology

This study introduces the conceptualization of a heat exchanger network (HEN) for a sugar mill located in the Valle del Cauca region, employing Pinch technology. The Pinch methodology is a straightforward approach to systematically investigating industrial processes, rooted in the fundamental principles of thermodynamics' first and second laws as expressed in (27). The methodology for developing a computational tool for implementing the Pinch methodology that we have used focuses on creating software that facilitates the analysis and optimization of thermal processes in the industry. Using the Matlab programming environment, a graphical user interface is developed that allows engineers to interact with the program intuitively. This tool is based on the principles of the first and second laws of thermodynamics, allowing the identification of opportunities for energy recovery and the minimization of energy costs in processes such as heating, evaporation, and crystallization in sugar production. Through this implementation, we seek to improve the efficiency of the design of heat exchange networks and contribute to the sustainability of the production process.

Figure 1 shows the program's initial window. The Data panel at the top displays the data incorporated into the program throughout the analysis. The Cascade panel on the right side of the window dynamically displays the Pinch analysis cascade algorithm. At the bottom, within the curves panel, the results of the Pinch analysis can be displayed through a series of graphs. By having two spaces to graph, the user can compare their results if they wish.

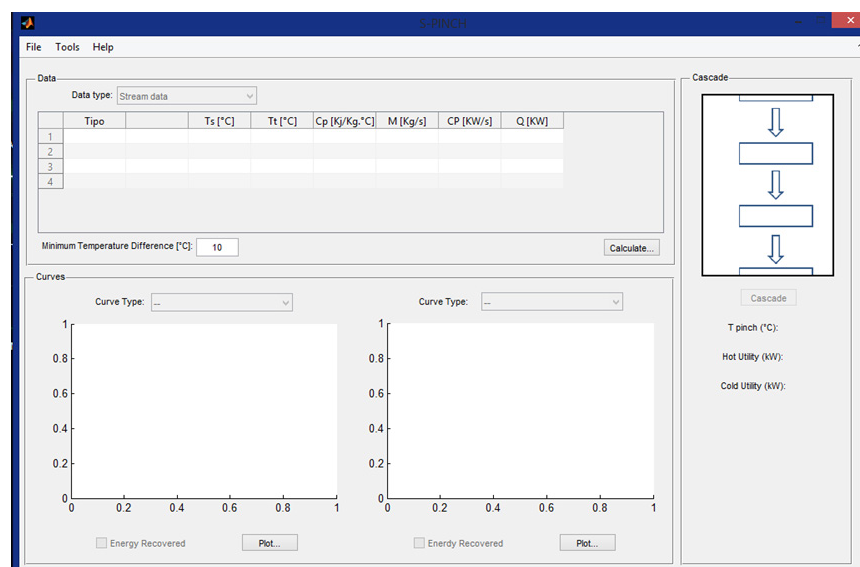

Figure 1. Pinch method graphical interface.

Steps to implement the Pinch Methodology

Identification of hot and cold streams and process utilities: In the Pinch method, a hot stream decreases its energy (the exit temperature is lower than the inlet temperature,

or there is condensation). On the contrary, a cold stream increases its energy (the exit temperature is higher than the entry temperature, or there is evaporation). Process utilities are all additional fluids used as a cooling medium (cold utilities) or heating media (hot utilities). For this case, we identify hot and cold streams and utilities from the mass and process energy balance. The reliability of these data is essential to have conclusive and truthful results. Thus, we could confirm data by measuring instruments currently in operation (18)(28).

Extracting thermal data from processes and utilities: For each hot, cold stream or utility identified, the following process data must be obtained (18)(28):

Supply temperature (T_s): It is the temperature at which the current is available.

Target temperature (T_t): Temperature to which the current must be brought.

Heat flow capacity (CP): Product between the mass flow and the specific heat of the fluid.

Enthalpy change (H): It is associated with the streams that pass through the heat exchanger.

Initial value selection ΔT_{min} : The minimum driving force for heat transfer within a heat exchanger for its design to be feasible is known as ΔT_{min} . In specialized literature, it is recommended that, for this type of industry, this value should be approximately 10°C . However, it may vary for other industries (18)(28).

Construction of compound curves and the great compound curve: A compound curve represents the sum of the process currents. The hot composite curve represents the set of hot currents, and the cold composite curve represents the set of cold currents. The objective of a compound curve, with the ΔT_{min} selected, is to deliver the amount of energy exchanged by the process streams and the minimum consumption of hot and cold utilities. That large composite curve is obtained by carrying out the heat cascade and minimum consumption of cold and hot utilities is also accepted. In addition, it allows identifying the Pinch temperature and the temperature levels of the process stream or utility necessary to meet process requirements (18)(28).

Heat exchanger network design: A heat exchange network is a diagram where you can observe the intersection of process streams and utilities in heat exchangers. This design must consider the selected ΔT_{min} , because it is directly related to the area of the exchanger and the cost of utilities. The higher this ΔT_{min} is, the more the cost of utilities increases, and the area becomes smaller and vice versa (18)(28).

Selection of the optimal ΔT_{min} : In this last stage, an optimal value of ΔT_{min} for which total costs become minimum, is determined. This process consists of repeating the entire energy integration, selecting different values of ΔT_{min} in each repetition and graphically representing the cost for each of these values. From the graph it is possible to estimate the point of ΔT_{min} where the cost becomes minimum (18)(28).

Economic analysis

The economic analysis for the investigation involved several key steps, starting with the collection of relevant financial data from the sugar production plant, including operational costs, energy consumption rates, and utility expenses. Utilizing the Pinch methodology, the analysis identified potential energy savings, particularly in heating and evaporation processes, and calculated the resulting reduction in utility costs. A cost-benefit analysis was

conducted to estimate annual savings against the initial investment required for the heat exchange network, allowing for the calculation of return on investment (ROI) and payback period. Additionally, a sensitivity analysis was performed to assess how variations in key variables, such as energy prices and operational costs, could impact economic outcomes.

Development of computational tool in Matlab

We developed an algorithm in Matlab R2023a to execute the procedure mentioned above. It is imperative to ascertain the operation's currents and utilities and identify the thermal information associated with it. This information must be manually inputted into the tool or through a spreadsheet, as depicted in Figure 2.

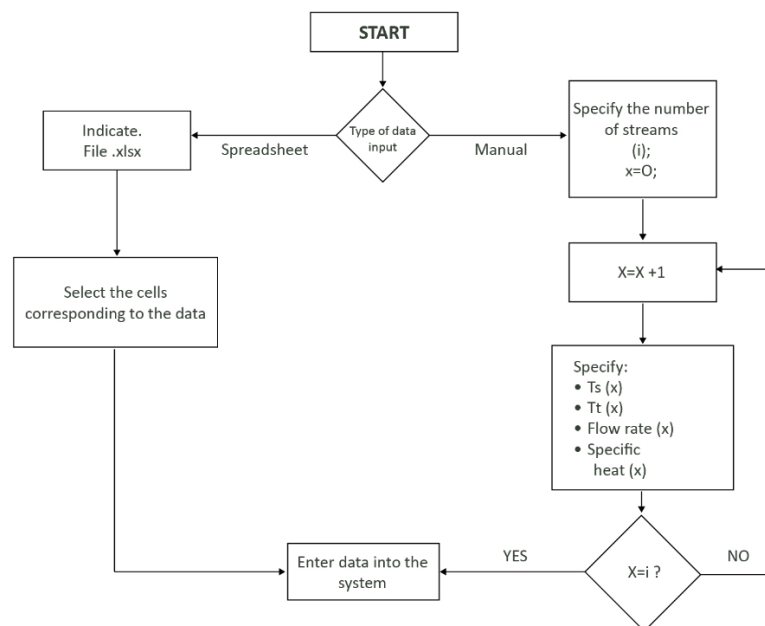

Figure 2. Data entry flowchart.

After this, the tool performs the heat cascade algorithm, thus obtaining the Pinch temperature and the cooling and heating utilities that can be achieved. The currents are rearranged, and temperature intervals are generated, as shown in Figure 3.

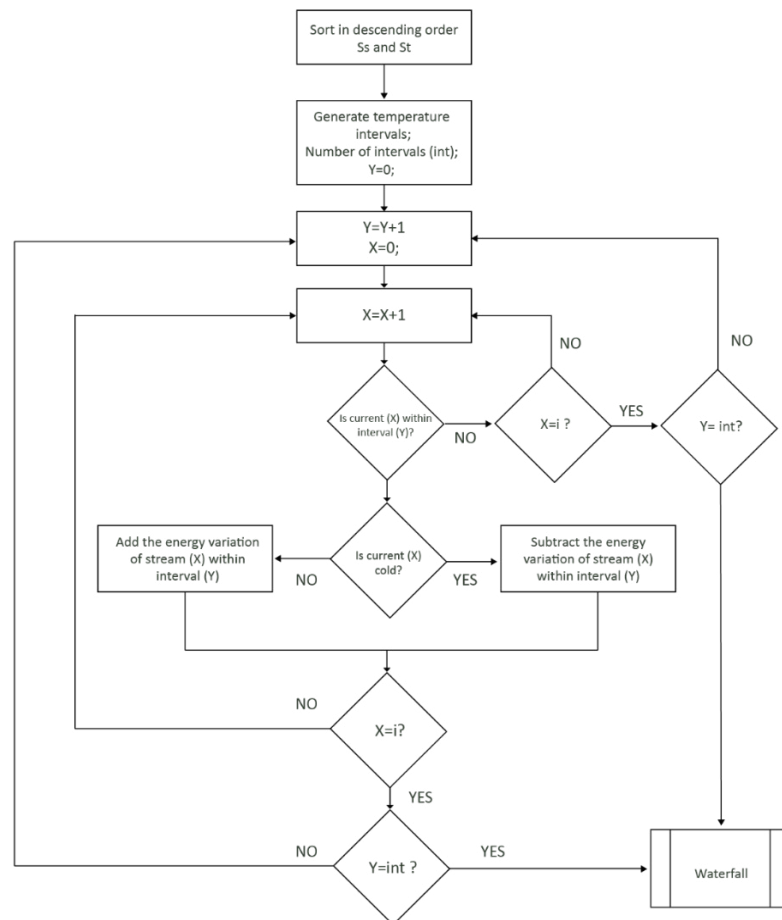

Figure 3. Problem table algorithm diagram.

In this diagram, it is observed how it ends in another process called waterfall. This diagram shows the algorithm of the problem table used by the tool. Depending on the current type, the current must be shifted by half of the ΔT_{min} . Matlab utilization achieves and increases the effectiveness of Pinch technology's programming. A collection of algorithms is created, which produces a program capable of conducting Pinch analysis in conjunction with a visual interface. This tool is of great value to engineers specializing in energy efficiency within industrial facilities. The data incorporated into the program throughout the analysis is displayed in a data panel at the top. The Pinch analysis cascade algorithm is dynamically exhibited in the cascade panel on the window's right side. Through a series of graphs, the results of the Pinch analysis are observed in the Curves panel positioned at the bottom. If desired, the user can compare their results by utilizing the two available spaces for graphing. Plotting cold, hot, compound, and large compound curves in this section is possible.

Characteristics of the streams to be integrated

We used the applied tool to treat juice in a sugar production facility in Valle del Cauca, Colombia. Juice treatment aims to eliminate impurities found in the juice to enhance its quality. Following this, the step is the liming phase, where lime milk is incorporated, and the juice is heated to a temperature of 105 °C to facilitate chemical reactions. The heated juice then undergoes a flash tank and a clarifier, where reactions produce sediments that settle down, thus separating them from the juice directed to the clarified evaporators.

After that, the separated material is filtered through rotary filters and presses that operate under vacuum. At this stage, the juice found in the sediments is recovered and returned to the liming process. The resulting sediment is used as fertilizer in the sugarcane field. The sequence of operations in the juice treatment stage is illustrated in figure 4.

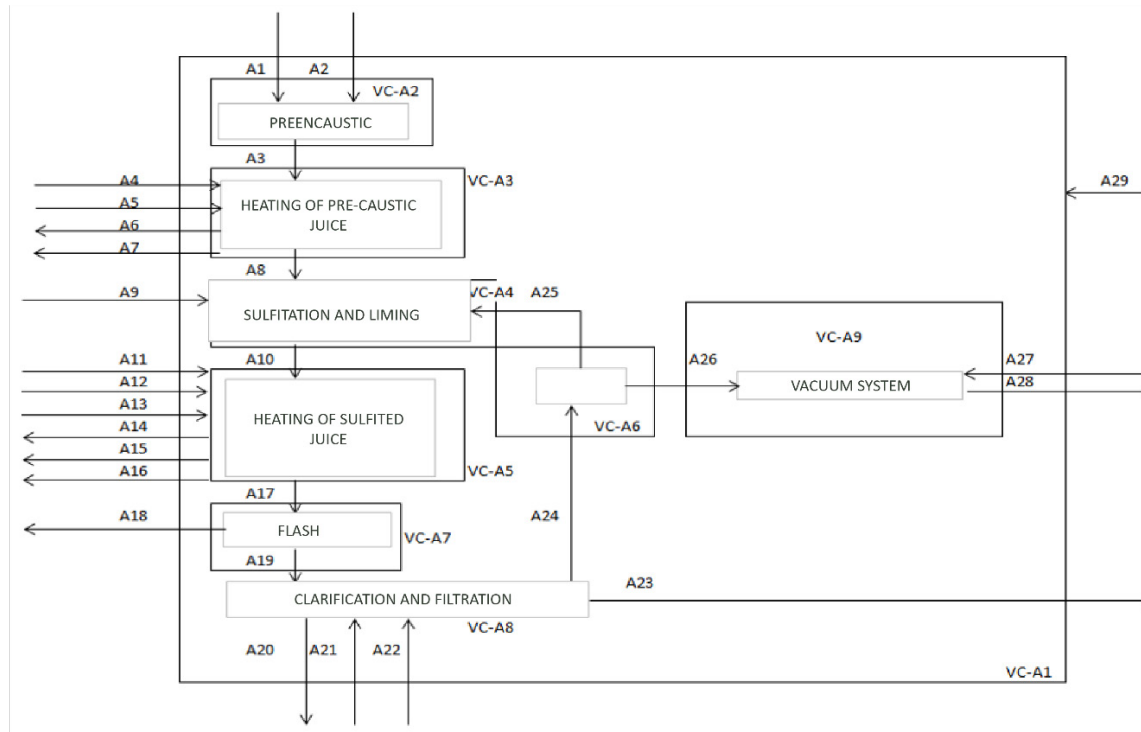

Figure 4. Sequence of operations in the juice treatment stage (subsystem 1)

Table 1 also describes the juice treatment operations stage (subsystem 1). Table 1 shows the sequence of operations for the juice heating process. Various parameters such as flows, temperatures, pressures, enthalpies, and specific heats were determined through the mass, soluble solids, sucrose, and energy balances.

The enthalpy change is associated with the streams passing through the exchanger. It is given by the first law of thermodynamics which can be expressed in Eq. (1):

$$\dot{Q} + \dot{W} = \Delta H \quad (1)$$



Table 1 Characteristics of juice treatment process streams

	Description		Description
A1	Raw Juice	A16	Steam condensates 1
A2	Lime	A17	Sulfite Juice at 102°C
A3	Pre-limed Juice	A18	Flash Steam
A4	Condensed water	A19	Sulfite juice to clarify
A5	Steam 4	A20	Clear juice
A6	Condensed water	A21	Bagasse
A7	Steam condensates 4	A22	Cake washing water
A8	Pre-limed juice at 85°C	A23	Cachaça cake
A9	Sulfur dioxide and lime	A24	Filtered juice
A10	Sulfite Juice	A25	Recirculated juice
A11	Steam 2	A26	Air – filtration vapors
A12	Steam 3	A27	Water for vacuum system
A13	Steam 1	A28	Vacuum system condensate
A14	Steam condensates 3	A29	Electric power
A15	Steam condensates 2		

The enthalpy change can be expressed in terms of the specific heat when it is considered constant, given by Eq. (2):

$$\Delta H = C_p(T_s - T_0) \quad (2)$$

T_s is the Celsius or Kelvin temperature at which the current is available and T_0 is the temperature in Celsius or Kelvin to which the current must be brought and C_p is the specific heat at constant pressure in units of [kJ/(kg· K)].

Once all the streams are represented, the heat exchangers are placed between them. The heat that must be exchanged is indicated on each heat exchanger and the entry and exit

temperatures of each stream to each of them are calculated using Eqs. (3) and (4):

$$T_{\text{outlet,hot current}} = T_{\text{inlet,hot current}} - \frac{\dot{Q}}{\dot{m}C_p} \quad (3)$$

$$T_{\text{outlet,cold current}} = T_{\text{inlet,cold current}} + \frac{\dot{Q}}{\dot{m}C_p} \quad (4)$$

A shell and tube heat exchanger is one of the types of exchanger design, which has a large number of tubes packed in a shell with important parameters being their length and the number of passes through the shell, normally these are the most used in the Colombian sugar sector for heating juices. To calculate the heat transfer areas, the logarithmic mean temperature difference method is used to estimate the heat transfer area, this is expressed in Eq. (5).

$$\dot{Q} = UA\Delta T_{\text{DMLT}} \quad (5)$$

\dot{Q} is the heat transfer in the exchanger in Watts, U is the overall heat transfer coefficient [$W/(m^2 \cdot ^\circ C)$], A heat transfer area and ΔT_{DMLT} is the log mean temperature difference. The value of this log mean difference between the streams can be expressed by Eq. (6).

$$\Delta T_{\text{DMLT}} = \frac{(T_{\text{inlet,hot}} - T_{\text{outlet,cold}}) - (T_{\text{outlet,hot}} - T_{\text{inlet,cold}})}{\ln \left(\frac{T_{\text{inlet,hot}} - T_{\text{outlet,cold}}}{T_{\text{outlet,hot}} - T_{\text{inlet,cold}}} \right)} \quad (6)$$

$T_{\text{inlet,hot}}$ = The temperature of the hot fluid at the inlet of the heat exchanger.

$T_{\text{outlet,cold}}$ = The temperature of the cold fluid at the outlet of the heat exchanger.

$T_{\text{outlet,hot}}$ = The temperature of the hot fluid at the outlet of the heat exchanger.

$T_{\text{inlet,cold}}$ = The temperature of the cold fluid at the inlet of the heat exchanger.

Stream heat exchange network of heating process

The first effect steam consumption is very high for heating Sulfite juice, which is why Heating subsystem 1 will be the starting point and the most important of the analysis. Another important point is that the clarified juice is not being heated to the saturation temperature, therefore, the evaporation system must not only carry out its primary function evaporate, but must also carry out a heating process initially, carrying the system to consume more energy and sometimes to unbalance the process causing lost time in the factory.

This study and redesign of the heat exchanger network focuses, due to its effect on other processes, on the juice treatment system. Below, Figure 5 shows the stream juice treatment system.

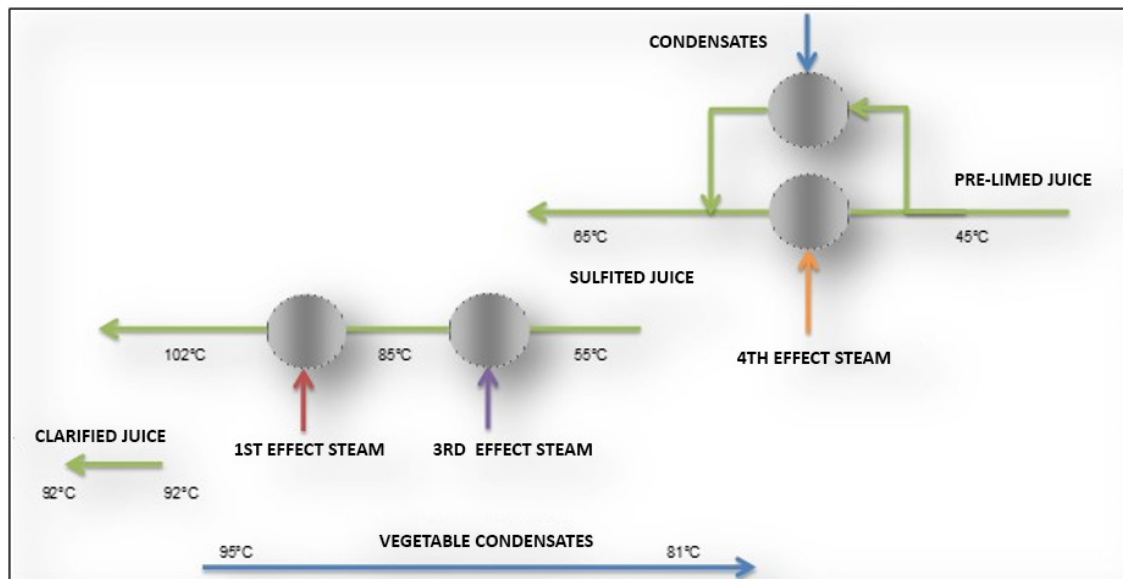

Figure 5. Current juice treatment system.

This analysis includes the main streams that require heating or cooling to comply with the sugar production process. According to figure 5, there are three cold streams, pre-limed juice, sulfite juice and clear juice. The hot stream that requires cooling is the condensate that is produced throughout the production process. Regarding the consumption of utilities, it can be said that the steam consumption of the first effect is very high for the heating of sulfite juice, which is why the treatment of juices will be the center of the analysis. Another important point is that the clarified juice is not being heated to the saturation temperature, therefore, the evaporation system must not only carry out its primary function of evaporating, but must also carry out a heating process, bringing the system consume more energy and sometimes unbalance the process, causing lost time in the factory.

Results and Discussion

Table 2 is obtained from the mass and energy balance, which actually shows the usable streams of the condensate, discounting the flows required by the other areas of the process. The streams with potential for energy integration can then be seen in this same table.

Table 2 Process streams identified with thermal integration potential-condensate use

Stream	Description	Inlet Temperature (°C)	Outlet Temperature (°C)	Q (kW)	C (kW/K)
F1	Pre-limed Juice	45	65	27,207	878
F2	Sulfite Juice	55	102	41,249	878
F3	Clear Juice	92	115	17,239	784
C1	Process condensates	95	80	7,635	509
C2	Process condensates	80	40	8,203	205

The value of ΔT_{min} initially taken is 7.3 °C, which corresponds to the minimum temperature difference achieved in one of the process equipment for heating juice. As results of the analysis of the tabular method, the hot utility goals of 136,257 kW and 42,167 kW for the cold one are obtained.

Using the tabular method described above in the areas of juice treatment, evaporation and crystallization, the minimum demand for hot and cold utilities was estimated. The determination of utility consumption goals was carried out with the developed computational tool. This tool allows obtaining composite curves in a system of temperature as a function of enthalpy as shown in Figure 6.

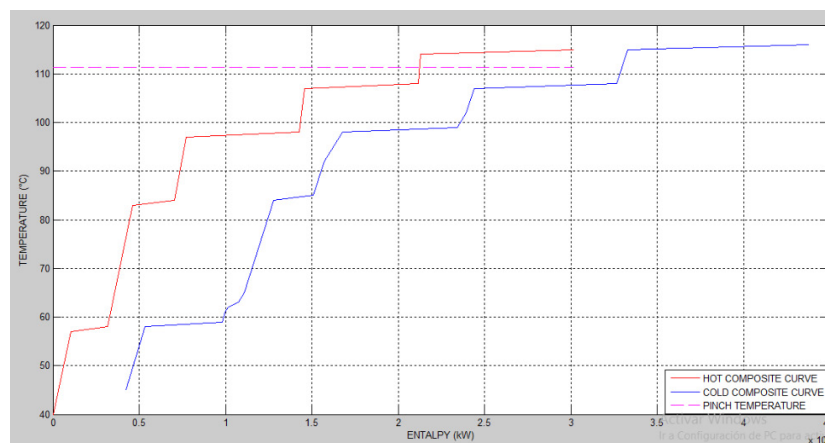

Figure 6. Composite curve.

The composite curves represented in figure 6 shows that the Pinch point of the process is at 111.35 °C, which represents a temperature very close to the operating point of the first evaporation effect, indicating a greater consumption of this steam in the process. Figures 6 and 7 present the composite curves and the large composite curve, respectively. These show the potential for energy savings, with the overlap between the cold and hot curves representing the heat recovery between the curves.

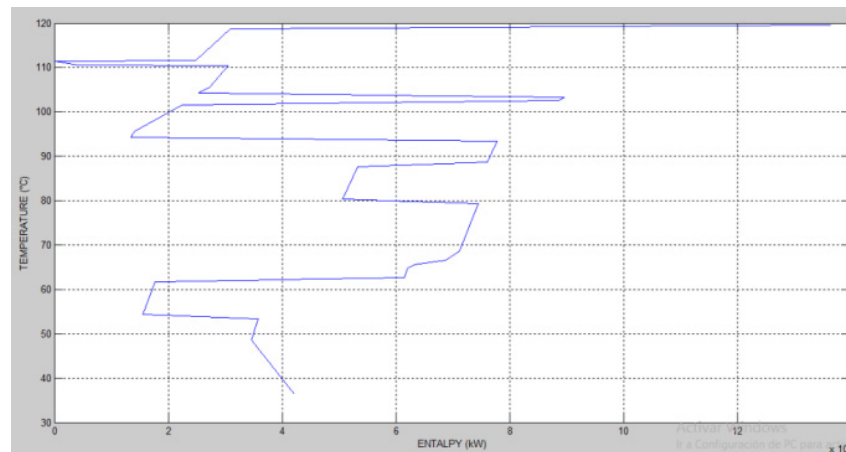

Figure 7. Large composite curve.

In Fig. 8, the process stream crossings are executed, exhausting all the energy coming from the only hot stream in the case of juice heating. Considering the large composite curve of the heating system, it is observed that the heating levels vary according to the available currents. It is decided not to use steam 4 since its energy contribution would be insufficient, allowing only a 4 °C increase in the temperature of the sulfite juice, from 71°C to 75°C, because the ΔT_{\min} is 10°C concerning the temperature of steam 4. Instead, the analysis begins by using steam 3 (at 101°C) in the second heating stage, managing to increase the juice temperature from 71°C to 91°C, maintaining a ΔT_{\min} of 10°C. Subsequently, steam 2 (at 110°C) is used to heat the juice from 91°C to 100°C. Finally, steam 1 brings the sulfite juice temperature to its final value of 102°C.

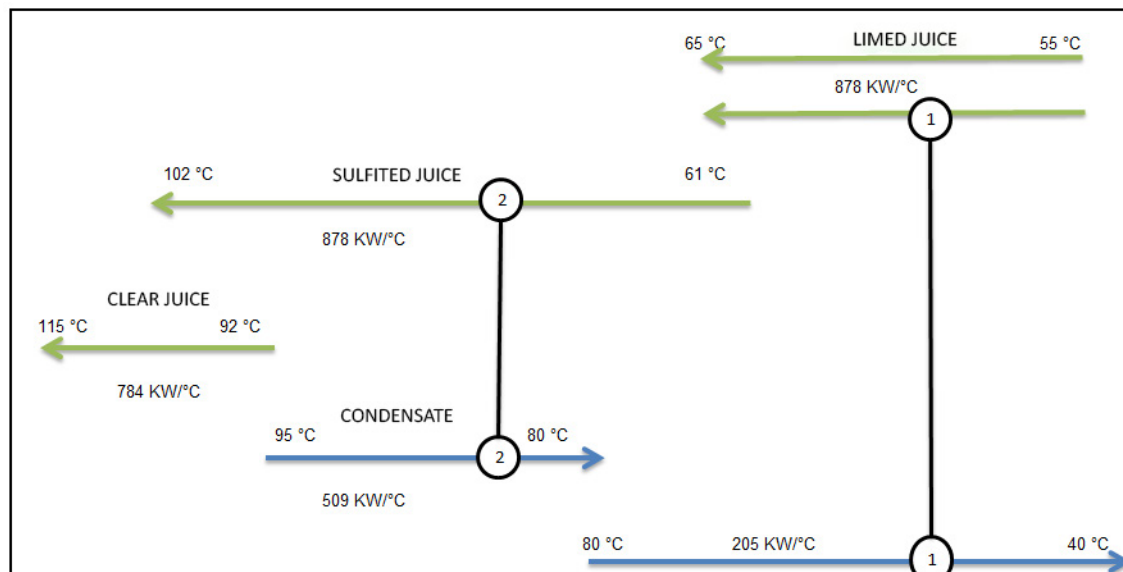

Figure 8. Initial juice treatment scheme-limed juice division.

This figure shows the best configuration for the use of the energy contained in each of the streams of this process; now to comply with the Pinch rules it is necessary that the heating of clarified juice be carried out with utilities other than exhaust steam (hot utility), at least below the Pinch temperature of the complete system 111 °C. For this, it is necessary to know which process streams could be used to comply with the heating of the clear juice taking into account a ΔT_{\min} of 7.3°C. From the large composite curve, the heat sources of the process are obtained that can be used to meet the heating objectives of the process, this can be seen in table 3.

Table 3 Availability of hot process streams

Process Heat Source	Work Pressure psig	Temperature °C
Steam 1 (first effect)	13.94	118
Steam 2 (second effect)	7.87	110
Steam 3 (third effect)	1.81	101
Steam 4 (fourth effect)	4.25	87
Steam 5 (fifth effect)	10.31	60

According to the previous table, the heat exchange network for heating clear juice is constructed, considering a ΔT_{min} of 7.3 °C. The use of steam for the fourth and fifth effect is ruled out because their temperature is lower than the inlet temperature of the clear juice (92 °C) plus the 7.3 °C of ΔT_{min} ; that is, it is lower than 99.3 °C. Therefore, only the use of vapors 1 and 2 is possible. This energy exchange proposal defines the currents and the amount of heat they exchange between themselves, as seen in figure 8.

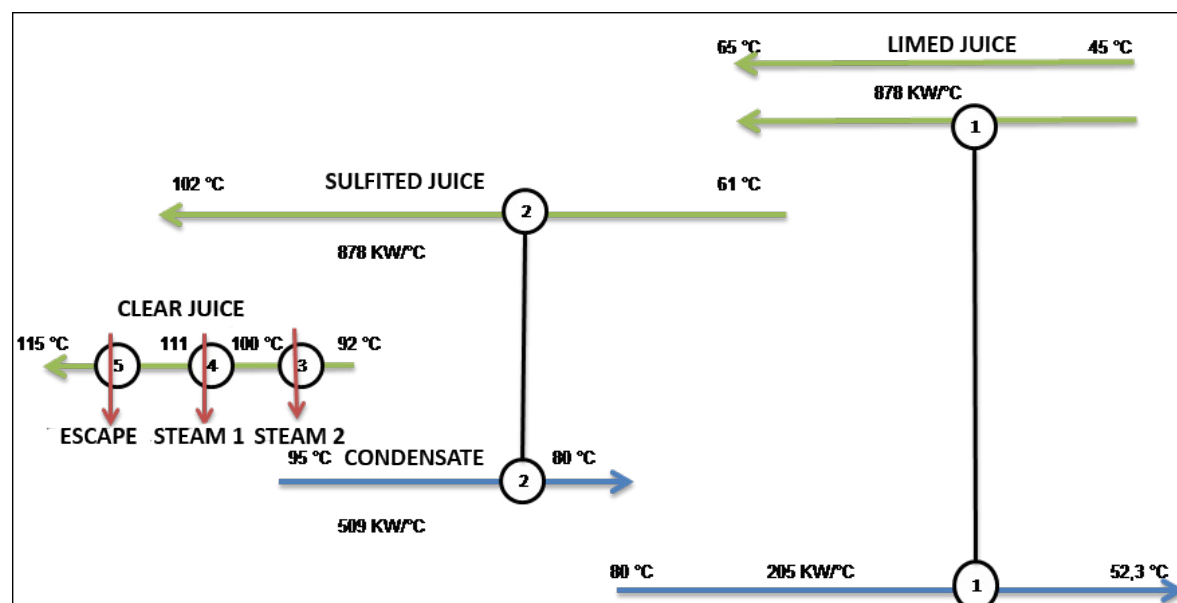

Figure 8. Final clear juice heating scheme.

To heat 60% of the sulfite juice, steam 4 (Operating temperature: 87 °C) will be used as a hot stream. The juice will be heated from 45°C to 65°C.

The following tables show the results with the new hot and cold utility consumption:

Table 4 consumption of hot utilities after application of the Pinch methodology

Subsystem	Mass flow (kg/s)	Thermal load (kW)
Evaporation lines	61	101,908
Distillery	10.6	17,631
Deaerator	4.3	7,219
Losses	1.6	2,714
Total	77.5	129,472

Table 5 consumption of cold utilities after application of the Pinch methodology

Subsystem	Mass flow (kg/s)	Thermal load (kW)
fifth effect cooling water	236.6	14,725
Cooling water to seedbed A	59.2	3,817
Cooling water tank A	391.3	23,157
Cooling water to seedbed B	34.1	2,197
Cooling water tank B	119.7	7,084
Total	840.9	50,980

With the design of the heat exchange network, a considerable decrease in the consumption of the hot utility is obtained, going from 146,577 kW to 129,472 kW, producing a saving of 17% with respect to the stream heat exchange network without modifications.

After this process is finished, the design of the exchange network must be completed to supply the energy needs of the process. For this, vegetable vapors from the evaporation line are used at different temperatures, according to Table 3. With the exchange network designed to comply with the Pinch rules, the exchange area necessary for each piece of equipment is calculated. Table 6 reports the areas of the proposed heat exchangers, which can be seen below.

Table 6 Calculation of heat exchange areas

Heat Exchanger	Temperature changes of cold streams °C		Temperature changes of hot streams °C		Q (kW)	A (m ²)
1	45	65	80	52.3	6,146	342
2	61	71	95	80	7,940	232
3	92	102.7	110	110	8,385	452
4	99	111	118	118	9,168	479
5	111	115	130	130	3,370	126
6	71	91	101	101		616
7	91	100	110	110	7,899	360
8	100	102	118	118	1,755	66
9	45	65	85	85		233

The economic analysis of energy integration includes the cost of utility consumption and the cost of amortization of the investment in the exchangers.

The cost of utilities was estimated directly from the cost of steam generation and the cost of pumping each m³ of cooling water, data obtained from the databases of the analyzed plant as can be seen in Table 7.

Table 7 Cost of utilities

Utility	Unitary cost
Low pressure steam (20 psig)	3 \$/lb
Cooling water	11.65 \$/m ³

Table 8 shows the expected savings after applying the Pinch methodology. The total annual savings due to the decrease in the consumption of hot and cold utilities of the process supporting this work is 461,892 USD. To estimate the costs of the heat exchange area, the manufacturing cost ratio of shell and tube heaters, with A36 steel body and 304 stainless steel exchange pipe, is used, for a value of 296.43 \$/m². This is a value supplied by the company that manufactures this equipment certified by foreign designers. Of the total number of exchangers, only equipment 3, 4, 5, 7 and 8 are included, given that the others are in the plant's warehouse. The sum of the area corresponding to these new heat exchangers is equivalent to 1.483 m², at a capital cost of 439,601.69 USD.

Table 8 Expected savings after applying Pinch method

	Consumption of cold utilities (kW)	Consumption of hot utilities (kW)
Without Pinch	60,121	146,577
With Pinch	50,980	129,472
Saved Energy	9,141	17,105
Saving \$/año	15,763.57	461,892

In this way, a return on investment would be expected after approximately one year of operation. This result is obtained through a simple payback or recovery period, dividing the cost of the exchange equipment by the expected savings due to a decrease in the consumption of hot and cold utilities.

It should be taken into account that everything corresponding to the assembly and installation of the exchange equipment is excluded from the scope of this work; each production plant will have different budgets for this item taking into account the layout of the equipment.

Conclusions

A specific computer program developed allows Pinch technology to be applied effectively, allowing energy integrations from simple processes to processes with hundreds of streams. Its programming and development reduce analysis times when comparing different ΔT_{min} .

The theoretical analysis of the potential for energy savings in the production plant studied a possible decrease in the consumption of hot and cold utilities, estimating a savings of 7% for hot and 30% for cold utilities. An annual savings of 461,892 USD in utility consumption is projected, applying the Pinch methodology. It is important to note that the plant was already in the energy improvement process without considering the second law of thermodynamics. During this study, additional improvements were proposed that contributed to reducing hot and cold utility consumption, thus optimizing the plant's energy performance.

The simulation and analysis of the heating processes, together with the energy integration in the heat exchanger network, demonstrate that applying the Pinch methodology can achieve significant optimization in the thermal efficiency of the sugar production plant. This approach not only allows better energy recovery and a reduction in the consumption of hot and cold utilities but also contributes to the sustainability of the process, generating substantial economic savings and improving the industry's competitiveness in the context of growing demand for more sustainable practices.

The economic analysis reveals that implementing the Pinch methodology, whether in a new or existing plant, offers significant cost-saving potential by focusing on acquiring essential heat exchange equipment, with an initial investment of 439,601.60 USD to cover a heat exchange area of 1.483 m². Although notable savings were found in the heating system exchanger network, a significant Pinch rule violation occurred during evaporation.



However, the crystallization system proved energetically efficient, effectively utilizing steam from the third evaporation effect.

CRediT authorship contribution statement

Julián Pérez Marín: conceptualization, Data curation, Methodology, Resources, Software, Visualization. Juan R. Vidal Medina: Formal analysis, Project administration, Methodology, Supervision, Validation. Yuri U. López Castrillón: Investigation, Writing – review & editing, Validation. Andrés F. Rodríguez Valencia: Investigation, Visualization, Writing – review & editing, Writing – original draft.

Ethical implications

The authors do not have any type of ethical involvement that should be declared in the writing and publication of this article.

Conflict of interest

The authors no declare.

Funding

No, the authors declare that they did not receive resources for the writing or publication of this article.

References

1. Julian Andrés Perez Marin. Análisis y evaluación de integración térmica de las corrientes de proceso en una planta de producción de azúcar para incrementar su eficiencia utilizando la metodología Pinch. Universidad Autónoma de Occidente. 2017.
2. Asocaña. Un dulce sabor que se transforma. Informe anual 2021 – 2022 [Internet]. Sector agroindustrial de la caña. 2022. Available from: <http://www.asocana.org/documentos/672022-B663EF18-00FF00,000A000,878787,C3C3C3,0F0F0F,B4B4B4,FF00FF,FFFFFF,2D2D2D,A3C4B5.pdf>
3. Palacios-Bereche MC, Palacios-Bereche R, Ensinas A V., Gallego AG, Modesto M, Nebra SA. Brazilian sugar cane industry – A survey on future improvements in the process energy management. *Energy*. 2022;259(June):1–19.
4. Dias MOS, Modesto M, Ensinas A V., Nebra SA, Filho RM, Rossell CEV. Improving bioethanol production from sugarcane: Evaluation of distillation, thermal integration and cogeneration systems. *Energy* [Internet]. 2011;36(6):3691–703. Available from: <http://dx.doi.org/10.1016/j.energy.2010.09.024>
5. Oliveira CM, Cruz AJG, Costa CBB. Improving second generation bioethanol production in sugarcane biorefineries through energy integration. *Appl Therm Eng* [Internet]. 2016;109:819–27. Available from: <http://dx.doi.org/10.1016/j.applthermaleng.2014.11.016>
6. Dias MOS, Ensinas A V., Nebra SA, Maciel Filho R, Rossell CEV, Maciel MRW. Production of bioethanol and other bio-based materials from sugarcane bagasse: Integration to conventional bioethanol production process. *Chem Eng Res Des*. 2009;87(9):1206–16.

7. Bonhivers JC, Ortiz PAS, Reddick C, Rossell CEV, Mariano AP, Filho RM. Graphical Analysis of Plant-Wide Heat Cascade for Increasing Energy Efficiency in the Production of Ethanol and Sugar from Sugarcane. *Process Integr Optim Sustain*. 2021;5(3):335–59.
8. Svensson E, Harvey S. Pinch Analysis of a Partly Integrated Pulp and Paper Mill. *Proc World Renew Energy Congr – Sweden, 8–13 May, 2011, Linköping, Sweden*. 2011;57:1521–8.
9. Safder U, Lim JY, How BS, Ifaei P, Heo SK, Yoo CK. Optimal configuration and economic analysis of PRO-retrofitted industrial networks for sustainable energy production and material recovery considering uncertainties: Bioethanol and sugar mill case study. *Renew Energy* [Internet]. 2022;182:797–816. Available from: <https://doi.org/10.1016/j.renene.2021.10.047>
10. Cortes-Rodríguez EF, Fukushima NA, Palacios-Bereche R, Ensinas A V., Nebra SA. Vinasse concentration and juice evaporation system integrated to the conventional ethanol production process from sugarcane – Heat integration and impacts in cogeneration system. *Renew Energy* [Internet]. 2018;115(1):474–88. Available from: <https://doi.org/10.1016/j.renene.2017.08.036>
11. Molina JBC. Integración energética del proceso de producción de alcohol en la destilería de un ingenio azucarero. Universidad Autónoma de Occidente. 2017.
12. Hurtado CMR, Rincon RG. Análisis y evaluación de integración térmica de las corrientes de proceso de la unidad de ruptura catalítica de ecopetrol gerencia refinera de cartagena utilizando la metodología Pinch. 2003.
13. Higa M, Freitas AJ, Bannwart AC, Zemp RJ. Thermal integration of multiple effect evaporator in sugar plant. *Appl Therm Eng* [Internet]. 2009;29(2–3):515–22. Available from: <http://dx.doi.org/10.1016/j.applthermaleng.2008.03.009>
14. Morandin M, Toffolo A, Lazzaretto A, Maréchal F, Ensinas A V., Nebra SA. Synthesis and parameter optimization of a combined sugar and ethanol production process integrated with a CHP system. *Energy* [Internet]. 2011;36(6):3675–90. Available from: <http://dx.doi.org/10.1016/j.energy.2010.10.063>
15. Pina EA, Palacios-Bereche R, Chavez-Rodrigues MF, Ensinas A V., Modesto M, Nebra SA. Thermal integration of different plant configurations of sugar and ethanol production from sugarcane. *Chem Eng Trans*. 2014;39(Special Issue):1147–52.
16. Ensinas A V., Nebra SA, Lozano MA, Serra L. Design of evaporation systems and heaters networks in sugar cane factories using a thermoeconomic optimization procedure. *Int J Thermodyn*. 2007;10(3):97–105.
17. Raghu Ram J, Banerjee R. Energy and cogeneration targeting for a sugar factory. *Appl Therm Eng*. 2003;23(12):1567–75.
18. Neto JNS, Pacheco JG, Sacramento LDA, Kalid R, Magalhães SLF De, Queiroz EM, et al. Energy integration - an example in a retrofit of a petrochemical plant. *2nd Mercosur Congr Chem Eng*. 2004;1–10.
19. Levasseur ZP, Palese V, Marechal F. Energy integration study of a multi-effect evaporator. *Ec Polytech Fed Lausanne*. 2008;1(1):1–17.



20. Llerena AC, Ones OP, Cardenas LZ de, Rios JLP de los. Integración energética del proceso de incineración de vinazas concentradas y generación de electricidad. *Rev Univ y Soc [Internet]*. 2021;13(6):286–94. Available from: <https://doi.org/10.1080/09638288.2019.1595750><https://doi.org/10.1080/17518423.2017.1368728><http://dx.doi.org/10.1080/17518423.2017.1368728><https://doi.org/10.1016/j.ridd.2020.103766><https://doi.org/10.1080/02640414.2019.1689076><https://doi.org/>
21. Chegini S, Dargahi R, Mahdavi A. Modification of Preheating Heat Exchanger Network in Crude Distillation Unit of Arak Refinery Based on Pinch Technology. *Proc World Congr Eng Comput Sci*. 2008;1(1):1–5.
22. Balla WH, Rabah AA, Abdallah BK. Pinch Analysis of Sugarcane Refinery Water Integration. *Sugar Tech*. 2018;20(2):122–34.
23. Smith R. State of the art in process integration. *Appl Therm Eng*. 2000;20(15):1337–45.
24. Linnhoff B, Dunford H, Smith R. Heat integration of distillation columns into overall processes. *Chem Eng Sci*. 1983;38(8):1175–88.
25. Klemeš JJ, Kravanja Z. Forty years of Heat Integration: Pinch Analysis (PA) and Mathematical Programming (MP). *Curr Opin Chem Eng*. 2013;2(4):461–74.
26. Varbanov PS, Yong JY, Klemeš JJ, Chin HH. Data extraction for heat integration and total site analysis: A review. *Chem Eng Trans*. 2019;76(1):67–72.
27. Fu D, Nguyen T, Lai Y, Lin L, Dong Z, Lyu M. Improved pinch-based method to calculate the capital cost target of heat exchanger network via evolving the spaghetti structure towards low-cost matching. *J Clean Prod [Internet]*. 2022;343(1):1–19. Available from: <https://doi.org/10.1016/j.jclepro.2022.131022>
28. Jaramillo Chica, Esteban-Sánchez Cossio JA. Desarrollo de una metodología para síntesis, optimización y diagnóstico de redes de transferencia de calor (HEN) – tratamiento de problemas con corrientes isotérmicas. 2009