

Simulation of the absorber layer thickness variation in SnS solar cells using Matlab

Simulación de la variación del espesor de la capa absorbente en células solares de SnS utilizando Matlab

Carlos Rondón Almeyda¹  Clara L. Rojas Rincón¹  Alexander Sepúlveda Sepúlveda²  Mónica A. Botero¹  María A. Mantilla¹ 

¹Universidad Industrial de Santander, Bucaramanga, Colombia

Abstract

The study of thin-film solar cells based on tin sulphide is becoming increasingly relevant due to its advantages over similar technologies, such as its low cost, toxicity, and the fact that its constituent elements are more abundant in the earth's crust; besides, they could be made by thig vacuum techniques like thermal spraying, sputtering, co-evaporation, or thermal evaporation. On the other hand, Simulations allow modelling of the behaviour of solar cells to understand the processes and improve the device's efficiency. Therefore, in this work, the simulation process is carried out using mathematical models that represent the physical behaviour of the solar cell made of heterojunction of several thin films with ZnO/ZnS/SnS configuration. Two radiation models were evaluated, one using a theoretical equation and the other with data from the incident radiation. Until today, different simulations of solar cells have been carried out mainly using a Solar Cell Capacitance Simulator (SCAPS); however, this research was developed using MATLAB due to its performance and efficiency. The optimal thickness of the absorbent layer was established from the results obtained for open circuit voltage (Voc), short circuit current density (Jsc), fill factor (FF) and conversion efficiency (η).

Resumen

El estudio de células solares de película delgada basadas en sulfuro de estaño está adquiriendo cada vez más relevancia debido a sus ventajas frente a tecnologías similares, como su bajo coste, toxicidad y el hecho de que sus elementos constitutivos son más abundantes en la corteza terrestre; Además, podrían fabricarse mediante técnicas de vacío muslo como pulverización térmica, pulverización catódica, coevaporación o evaporación térmica. Por otro lado, las Simulaciones permiten modelar el comportamiento de las células solares para comprender los procesos y mejorar la eficiencia del dispositivo. Por lo tanto, en este trabajo, el proceso de simulación se lleva a cabo utilizando modelos matemáticos que representan el comportamiento físico de la célula solar formada por heterounión de varias películas delgadas con configuración ZnO/ZnS/SnS. Se evaluaron dos modelos de radiación, uno utilizando una ecuación teórica y el otro con datos de la radiación incidente. Hasta el día de hoy se han realizado diferentes simulaciones de células solares utilizando principalmente un Simulador de Capacitancia de Células Solares (SCAPS); sin embargo, esta investigación se desarrolló utilizando MATLAB debido a su rendimiento y eficiencia. El espesor óptimo de la capa absorbente se estableció a partir de los resultados obtenidos para voltaje de circuito abierto (Voc), densidad de corriente de cortocircuito (Jsc), factor de llenado y eficiencia de conversión (η).

Keywords: thin-film, solar cells, SnS, efficiency, absorber thickness.

Palabras clave: película delgada, células solares, SnS, eficiencia, espesor del absorbente.

How to cite?

Rondón, C., Rojas, C.L., Sepúlveda, A., Botero, m.A., Mantilla, M.A. Simulación de la variación del espesor de la capa absorbente en células solares de SnS utilizando Matlab. Ingeniería y Competitividad, 2024, 26(3)e-20113982

<https://doi.org/10.25100/iyv.26i3.13982>

Recibido: 26-05-24
Aceptado: 12-08-24

Correspondence:
mabotero@saber.uis.edu.co

This work is licensed under a Creative Commons Attribution-NonCommercial-ShareAlike4.0 International License.



Conflict of interest: none declared

OPEN  ACCESS

Why was it conducted?:

In this work, a simulation of a thin film solar cell with ZnO/ZnS/SnS configuration was performed because our research group is interested in theoretically and experimentally investigating this technology. Our interest is to delve into the most efficient thin film solar cells in tropical areas because this technology is made of less toxic and expensive elements than those currently used in similar technologies and it is a technology that could make transit to a commercial level in Colombia, due to the synthesis methods in which it can be manufactured.

What were the most relevant results?

In addition, we decided to perform the simulation in Matlab because it allows us to understand the processes of electrical transport better, we can vary the parameters of interest to determine from the theoretical point of view how the cell would behave.

What do these results contribute?

Among the most relevant parameters we have, the efficiency can reach values higher than 16% for thicknesses in the order of 10nm. In the synthesis process it should be taken into account that the fill factor presents reduced values for thicknesses of the order of 2 and 6 nm, the width of the space charge zone is important because the thickness of the buffer layer (ZnS) should be less than this thickness to have better efficiencies.

Graphical Abstract

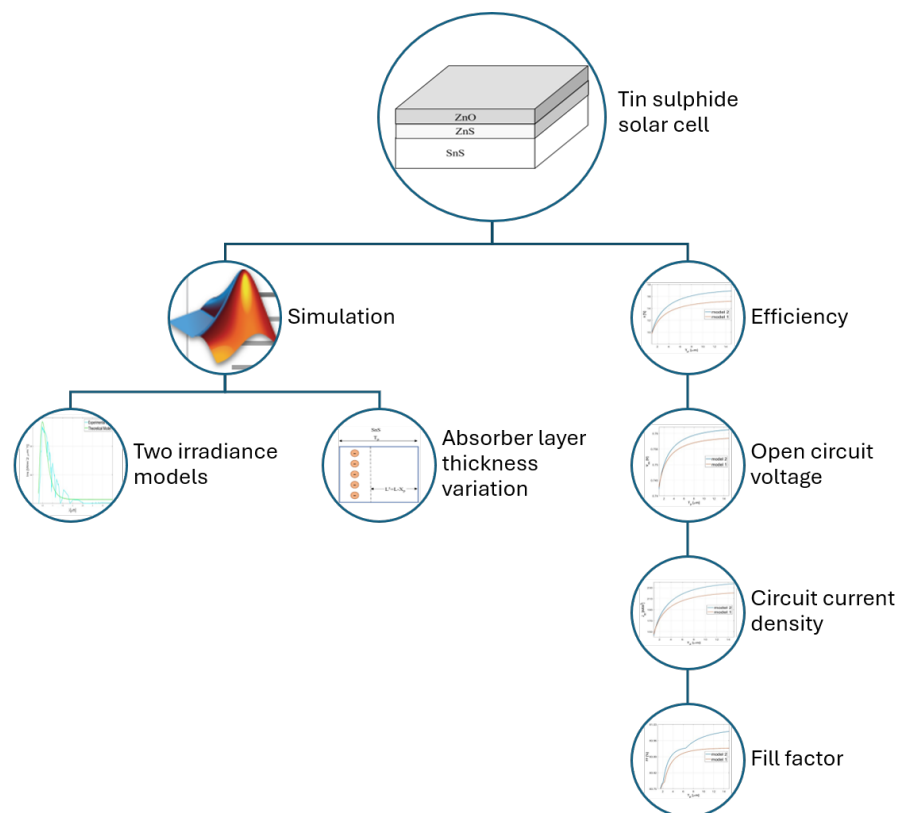

Introduction

Solar cells are a renewable energy technology that directly converts solar energy to electrical energy. The cells are compounds for different materials in the form of layers, and the junction among the p-type semiconductor and the n-type semiconductor creates a Space Charge Zone, which, when being irradiated with solar light, generates the photovoltaic effect (1). In thin-film solar cells, the absorber layer or p-type semiconductor creates the charge carriers, and the buffer layer is both an n-type semiconductor and a bridge between the absorber layer and transparent conductive oxide (2). Researchers are developing different materials for every layer to increase the efficiency of solar cells (3).

The objective of manufacturing solar cells without toxic and abundant elements in the earth's crust has made tin sulfide (SnS) a potential candidate to be used as an absorber layer in photovoltaic devices (4,5). On the other hand, SnS has attracted the attention of researchers owing to its being composed of elements non-toxicity, low cost, element abundance and have a theoretical efficiency of 25% (6). SnS absorbers are semiconductors inorganic films with an intrinsic conductivity p-type, a direct band gap of around 1.3 eV, and an absorption coefficient greater than 10^4 cm^{-1} (7,8). Besides, this kind of thin film can be made by different high vacuum techniques like sputtering, co-evaporation, vacuum evaporation, thermal evaporation, close spaced sublimation, electrodeposition, did deposition process, spray pyrolysis and so on (9).

In literature, it is possible to find some papers that simulate thin film solar cells, such as (10) who performed a numerical simulation with device configuration FTO/WS₂/Cu₂Te/Cu₂O/Au using wxAMPS program, L. Hafaifa et al. make a simulation of Cadmium Telluride (CdTe) thin-film solar cell with different buffer by means of the Silvaco-Atlas semiconductor device simulator. Hafaifa (11) and many papers used SCAPS-1D in the thin film solar cell (12–15). Respect to the simulation of SnS thin film solar cell most of the paper found perform the simulation using SCAPS (16–21), and some papers make simulations by COMSOL Multiphysics (22). However, an investigation of the SnS thin film solar cells varying the thickness of the absorber layer by mean of MATLAB has been unexplored.

This research was carried out using MATLAB software, and each film's optical and electrical properties which comprise the structure as input data. This paper is focused on the simulation of thin film solar cells with ZnO/ZnS/SnS structure through Software a MATLAB script to obtain, analyze and compare the outputs of main operation's parameters as such open-circuit voltage (V_{oc}), short-circuit current density (J_{sc}), fill factor (FF) and conversion efficiency (η). The simulation is carried out using mathematical models that represent the physical behavior of the solar cell. The script developed in Matlab gives greater versatility in the research, because it allows the authors to modify physical parameters of each material, include information on new data, include radiation data from a particular study site, and so on.

The development of this research contributes to selecting and understanding a structure that allows obtaining efficiencies to compete commercially with silicon cells. On the other hand, carrying out the simulation process reduces operational and experimental costs. Hence, in the future, resources can be optimized and prioritized in synthesizing new materials.

Methodology

Numerical Models

In this section, two irradiance models are introduced, and the mathematical equations that represent the behaviour of the ZnO/ZnS/SnS structure have been used to develop the simulation to figure out the output parameters as a function of absorber layer thickness. Besides, it is also presented the features that represent every film in the structure. This research will be able to determine an absorber layer thickness which increases the efficiency of the structure. Below (Figure 1), we can see the dimensions of every film representing the structure under study.

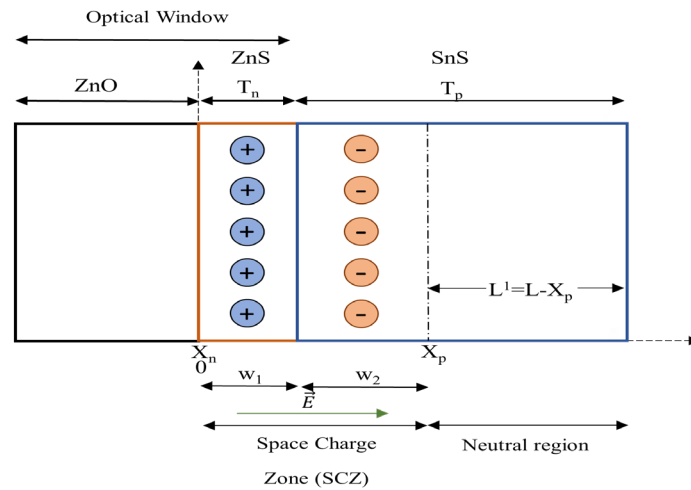

Figure 1. Dimensions of ZnO/ZnS/SnS structure

w_1 is the fraction of the Space Charge Zone (SCZ) in the buffer layer and w_2 is the fraction of the SCZ in the absorption layer. T_n represents the thickness of the buffer layer which for this analysis is equal to w_1 , T_p represents the thickness of the absorption layer and L is the sum of T_n y T_p . X_n^0 is the thickness of the neutral charge zone of the n layer which takes a value of zero for this analysis, X_p is defined as $X_p = w_1 + w_2$, and L^1 is the thickness of the neutral charge zone of the p layer.

Mathematical definition of SCZ

Based on the figure and assuming the reference axes starting point from the ZnS as a zero, it has been established from the literature (23,24) w_1 y w_2 as shown in the Ec. 1 and 2, respectively. V_d is the diffusion potential, ϵ_1 is the permittivity of the buffer layer (ZnS), and ϵ_2 is the permittivity of the absorber layer (SnS).

$$w_1 = \left(\frac{2V_d}{e} * \left[\frac{\epsilon_1 \epsilon_2}{\epsilon_1 N_d + \epsilon_2 N_a} \right] \right)^{\frac{1}{2}} * \left(\frac{N_d}{N_a} \right)^{\frac{1}{2}} \quad (1)$$

$$w_2 = \frac{N_d}{N_a} w_1 \quad (2)$$

Where, V_d is determined by the next Ec. 3 [11].

$$V_d = \frac{E_{g2} + x_2 - x_1}{e} + U_t \ln \left(\frac{N_a N_d}{N_{c1} N_{v2}} \right) \quad (3)$$

Where x_1 and x_2 are the electronic affinities of the absorbent and buffer layers, respectively, U_t is the thermodynamic potential that take a value of 25.7 mV, N_a and N_d are acceptors and donors' concentrations, respectively, N_{c1} is the effective conduction band density of the states, N_{v2} is the effective valence band density of the states, and E_{g2} is the SnS gap.

Irradiance Models

To carry out the research on the behaviour of ZnO/ZnS/SnS structure was applied both a theoretical model and an experimental model to determine the solar spectrum irradiance at ground level as a function of wavelength. The theoretical model is represented with Ec. 4 (25). The

experimental model is got from experimental data supplied by Nacional Aeronautics and Space Administration (NASA). In figure 2, both models can be observed.

$$I_{rs}(\lambda) = 0.06977 + 7.0625 \left(1 - e^{\frac{-(\lambda-0.26053)}{0.15994}} \right)^{2.28411} e^{\frac{-(\lambda-0.26053)}{0.15994}} \quad (4)$$

The solar spectrum irradiance at ground level as a function of wavelength is given below (Figure 2).

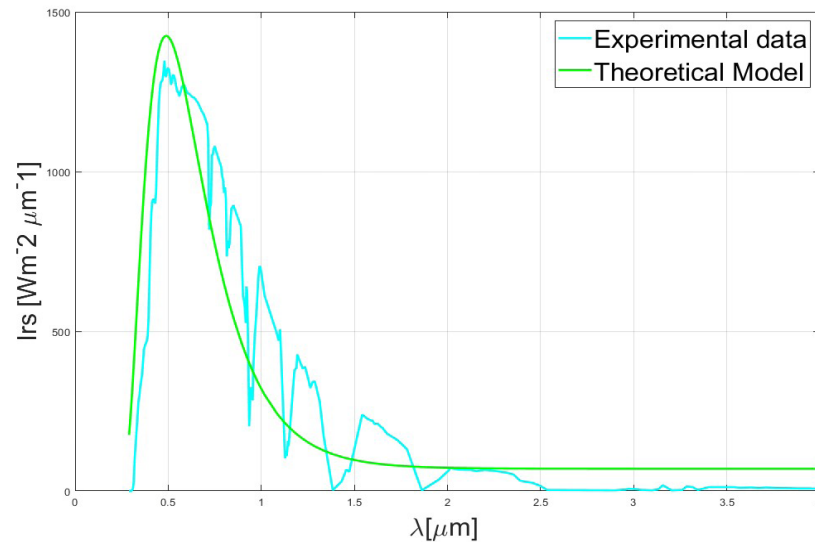

Figure 2. Solar spectrum irradiance at ground level as a function of wavelength. The experimental data was plotted in cyan, and the theoretical model was plotted in green.

Current density

The photocurrent's integral allows for calculating the current density (J_{ph}) for the entire range of the solar spectrum. The equation (Ec. 6) for the photocurrent is given by (26).

$$J_{ph} = \int_{\lambda_1}^{\lambda_2} J_{ph}(\lambda), \quad J_{ph}(\lambda) = J_p(\lambda) + J_{scz}(\lambda) + J_n(\lambda) \quad (6)$$

Where integral was evaluated by λ_1 and λ_2 with values of 0.29 μm and 8 μm , respectively. $J_{ph}(\lambda)$ is the sum of the current density due the movement of the electrons in the semiconductor type p (Ec. 7), the movement of the holes in the semiconductor type n (Ec. 8), and the current density in the space charge zone (Ec. 9). Each of the current densities has been obtained by the following equations (27).

$$J_p(\lambda) = \left(q \frac{I_{rs}(\lambda)(1-R)\alpha_1 L_p}{hv(\alpha_1^2 L_p^2 - 1)} \right) \left(\frac{\frac{S_p L_p}{D_p} + (e^{-\alpha_1 X_n}) \left(\frac{S_p L_p}{D_p} \cosh\left(\frac{X_n}{L_p}\right) + \sinh\left(\frac{X_n}{L_p}\right) \right)}{\frac{S_p L_p}{D_p} \sinh\left(\frac{X_n}{L_p}\right) + \cosh\left(\frac{X_n}{L_p}\right)} - \alpha_1 L_p (e^{-\alpha_1 X_n}) \right) \quad (7)$$

$$J_n(\lambda) = \left(q \frac{I_{rs}(\lambda)(1-R)\alpha_2 L_n}{hv(\alpha_2^2 L_n^2 - 1)} \right) (e^{-\alpha_1(X_n + w_1)} - \alpha_2 w_2) \quad (8)$$

$$\left(\alpha_2 L_n - \frac{\frac{S_n L_n}{D_n} (\cosh(\frac{L'}{L_n}) - e^{-\alpha_2 L'}) + \sinh(\frac{L'}{L_n}) + \alpha_2 L_n e^{-\alpha_2 L'}}{\frac{S_n L_n}{D_n} \sinh(\frac{L'}{L_n}) + \cosh(\frac{L'}{L_n})} \right)$$

$$\left(\alpha_2 L_n - \frac{\frac{S_n L_n}{D_n} (\cosh(\frac{L'}{L_n}) - e^{-\alpha_2 L'}) + \sinh(\frac{L'}{L_n}) + \alpha_2 L_n e^{-\alpha_2 L'}}{\frac{S_n L_n}{D_n} \sinh(\frac{L'}{L_n}) + \cosh(\frac{L'}{L_n})} \right)$$

$$J_{zce}(\lambda) = \left(q \frac{I_{rs}(\lambda)(1-R)e^{-\alpha_1 X_n (1 - e^{-\alpha_1 w_1 - \alpha_2 w_2})}}{hv} \right) \quad (9)$$

α_1 is the absorption coefficient of ZnS, α_2 is the absorption coefficient of SnS, R is their effectivity, D_n and D_p are the diffusion coefficients of electrons and holes, respectively, and L_n and L_p represent the electron and hole diffusion length, respectively.

Optical window absorption

In this analysis configuration, the ZnO and n-type ZnS are the optical window. ZnS have a wider bandgap of 3.58eV and is transparent in the wavelength of 350–550 nm (28) and ZnO is a Transparent conductive oxide. Then, knowing the amount of energy absorbed and in which wavelength it happened allows recognize how much irradiance arrives at the absorber layer. In Figure 3, the solar flux is plotted as a function of wavelength. It is observed that only a tiny fraction of solar flux is absorbed when the wavelength takes approximate values from 0.3 μm to 0.38 μm . Therefore, it is established that the ZnO is almost transparent to the configuration.

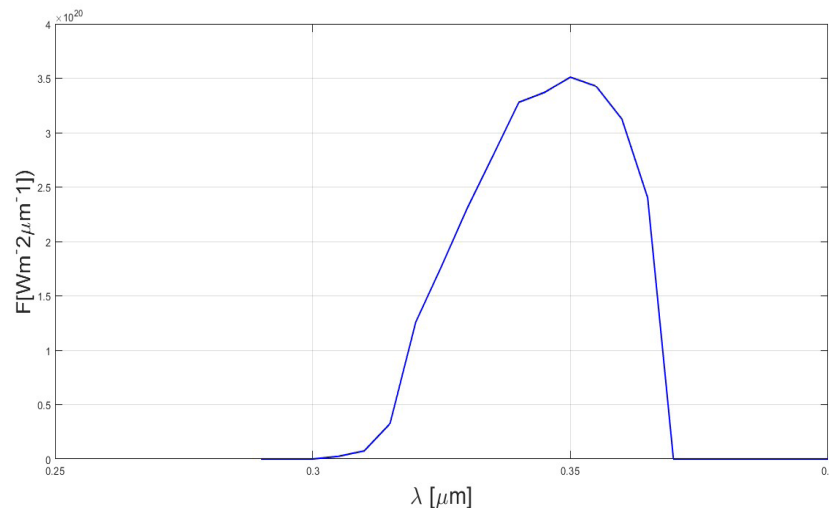

Figure 3. Solar flux at ZnO as a function of wavelength.

Simulation Parameters

The parameters used to carry out the simulation were established from the bibliographic research consulted. The optical constants data were obtained by applying transmittance as experimental data and COPS II as virtual data.

Absorption coefficient

The absorption coefficient and band gap were calculated from the transmittance spectra of the SnS and ZnS and the software COPS II (licensed product) software. Transmittance spectra was determined from thin film synthesized by evaporation in Universidad Industrial de Santander Laboratory. COPS II was developed by Universidad Industrial de Santander. Absorption coefficient of SnS and ZnS as a function of wavelength are shown in Figure 4.

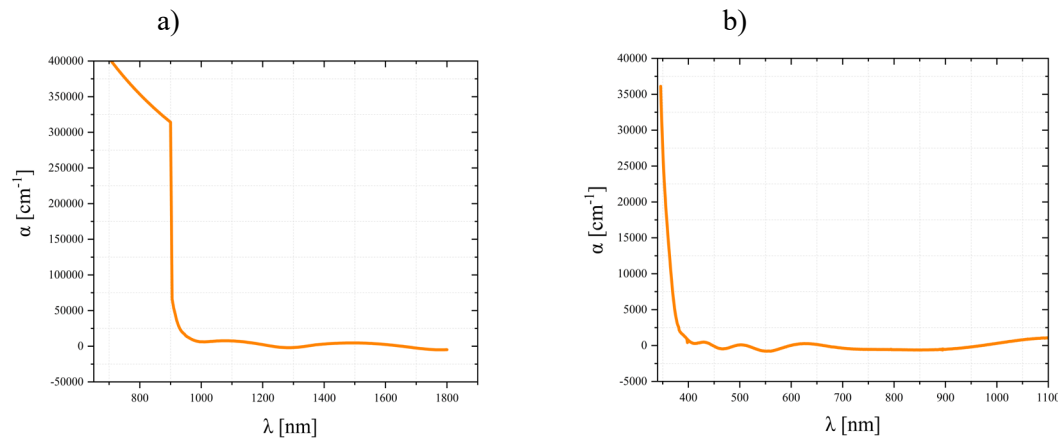

Figure 4. Absorption coefficient as a function of wavelength. a) SnS and b) ZnS

The band gap determined for the SnS thin film is 1.37 eV, for the ZnS thin film is 3.58 eV and for the ZnO thin film is 3.37 eV.

Features of structure ZnO/ZnS/SnS

In this study is used ZnO as transparent conductive oxide (TCO), SnS as absorbent film and ZnS as a buffer layer, resulting in the simulation of ZnO/ZnS/SnS structure. The parameters that were used in the simulation are presented in Table 1.

Table 1. Parameters used on simulation of both SnS and ZnS

Layer Properties	Symbol	Unit	SnS	ZnS	Reference
Acceptor concentration	N_a	m^{-3}	1.8×10^{22}		(29)
Donor concentration	N_d	m^{-3}		9×10^{23}	(30)
Relative permittivity	ϵ		12.5	9	(31,32)
Effective density of states	N_c	m^{-3}	7.5×10^{24}		(33)
Effective density of states	N_v	m^{-3}	1.0×10^{25}		(34)
Affinitive	x	eV	4.2	3.9	(35,36)
Recombination speed of the holes	S_p	m/s		10	(32)
Hole diffusion length	L_p	m	2.27×10^{-6}	2.48×10^{-6}	(31,32)
Diffusion coefficient of holes	D_p	$m^2 s^{-1}$	1.03×10^{-5}	1.03×10^{-4}	(31,32)
Recombination rate electrons	S_n	m/s	200		(37)
Diffusion coefficient of electrons	D_n	$m^2 s^{-1}$	2.57×10^{-4}	5.91×10^{-4}	(31,32)
Electron diffusion length	L_n	m	1.13×10^{-5}	3.44×10^{-6}	(31,32)
Band gap energy	E_g	eV	1.37	3.58	
Electron mobility	μ_n	$m^2/V.s$	1×10^{-2}	0.023	(31,32)
Holes mobility	μ_p	$m^2/V.s$	4×10^{-4}	4×10^{-3}	(31,32)

Simulation development

Development of the model was performed through the software MATLAB. The structural parameters of every film in the researched cell and the irradiance models were used as input data. From the code and the input data, the J_{ph} was determined as a function of wavelength. This value was calculated for every thickness value of the absorber layer. Afterwards, using the values of J_{ph} , the open circuit voltage (V_{oc}), short circuit current density (J_{sc}) fill factor (FF) and conversion efficiency (η) were calculated. With the results, the optimal thickness of the absorber layer was established. A schematic representation of simulation development is presented in the Figure 5.

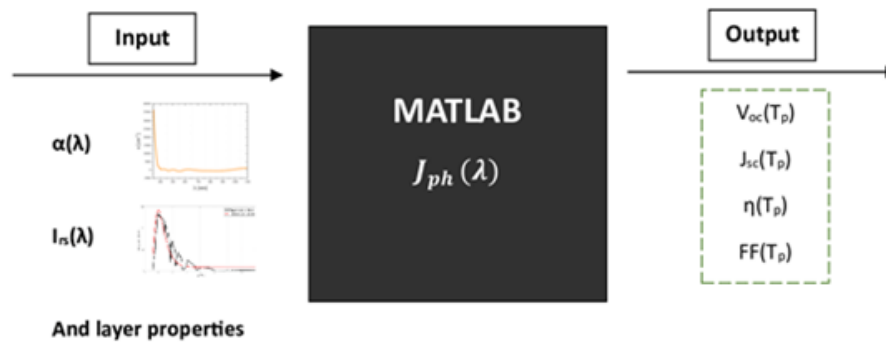

Figure 5. schematic representation of simulation development.

Results and discussion

The structure of solar cell ZnO/ZnS/SnS was simulated with the parameters presented in Table 1. The simulation was carried out by varying the thickness of the absorber layer from 1 μm to 15 μm . In this study, it was evaluated the short-circuit current density, the open-circuit voltage, the fill factor, and the conversion efficiency. This research considered a theoretical irradiance model (model 1) and an experimental irradiance model (model 2). Figure 4 presents the results obtained, and it is possible to see that both V_{oc} and J_{sc} show an increase in wavelengths among 1 μm and 8 μm , besides the plotted achieve higher values when the thickness is greater than 8 μm approximately. In this point, the V_{oc} and J_{sc} for model 1 are 0.757 V and 214 mA/m^2 , respectively. The V_{oc} and J_{sc} for model 2 are 0.759 V and 228 mA/m^2 , respectively. It could be established that model 2 generates values of conversion efficiency (η) higher than model 1. These values are approximately 1.4% higher. The values of conversion efficiency for model 1 and model 2 were 14.7% and 16.1%, respectively. Eventually, the FF achieved a value greater than 80.95% for the model 2. This is because the model 2 takes real values while the model 1 is a mathematical model (Figure 6).

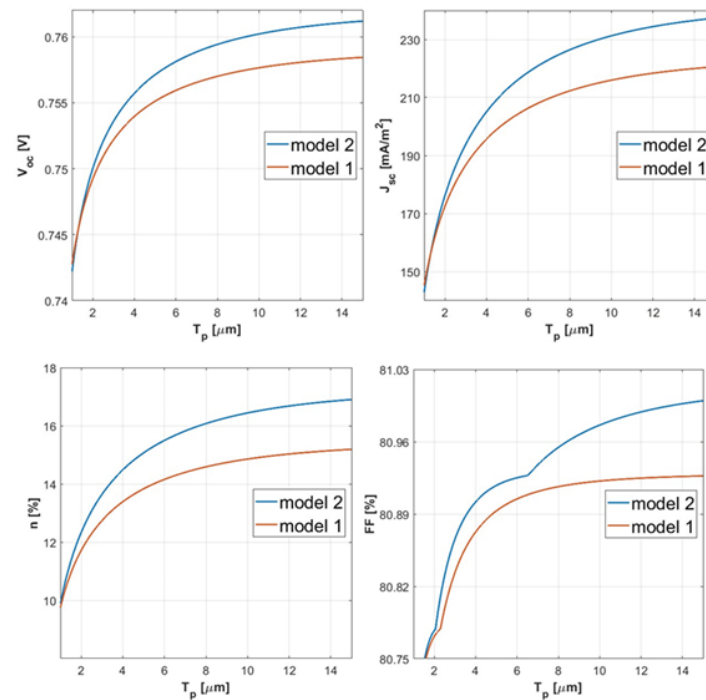

Figure 6. Open circuit voltage (V_{oc}), short circuit current density (J_{sc}) conversion efficient (n) and fill factor (FF) as a function of absorber layer thickness.

The values of w_1 inside the ZnS layer and w_2 inside the SnS layer are 6.589 nm and 329.45 nm, respectively. Hence, the SCZ thickness have a value of 336.04 nm. Due to the values generated for the simulation, it is possible determined that values of SnS layer greater than 8 μm present high efficiency. Thence, it is possible to stablish that for thickness higher than 8 μm the structure could absorber almost all of energy of the radiation. Besides, the structure could be built with $X_n = 0$.

Conclusions

In this research, it was made a simulation of the structure of solar cell ZnO/ZnS/SnS having a ZnS as a buffer layer and SnS as an absorber layer. The simulation allowed to study the influence through the variation of absorber thickness on the cell parameters.

The simulation was carried out in Matlab by mathematical model and experimental model of irradiance. It allowed to determine a width of the SCZ was 336.04 nm and due to this, is possible established that the J_{sc} grow quickly when the thickness of absorber layer is less than w_2 . Besides, the results indicate that if the absorber thickness is higher than 8 μm , it is possible absorber almost all of energy of radiation. The efficiency was achieved by thickness of 8 μm with the model 2 was 16.1% with an FF of 80.95%.

Also, the research gives as a result that the irradiance affects the cell parameters. Therefore, the experimental dates produced higher V_{oc} , J_{sc} , n and FF.

Acknowledgment

We thank The Universidad Industrial de Santander for the financial provided support through the project 3719.



References

1. Gurevich Y, Meléndez L. Fenómenos de contacto y sus aplicaciones en celdas solares. 1 Ed. México: Fondo de cultura Económica - FCE; 2010. 31–35.
2. Ullah H, Marí B. Numerical analysis of SnS based polycrystalline solar cells. Superlattices Microstruct. 2014 Aug;72:148–55.
3. Gul M, Kotak Y, Muneer T. Review on recent trend of solar photovoltaic technology. Energy Exploration & Exploitation. 2016 Jul 19;34(4):485–526.
4. Caballero R, Condé V, León M. SnS thin films grown by sulfurization of evaporated Sn layers: Effect of sulfurization temperature and pressure. Thin Solid Films. 2016 Aug;612:202–7.
5. Javed A, Khan N, Bashir S, Ahmad M, Bashir M. Thickness dependent structural, electrical and optical properties of cubic SnS thin films. Mater Chem Phys. 2020 May;246:122831.
6. Oomae H, Eguchi T, Tanaka K, Yamane M, Ohtsu N. X-ray diffraction and X-ray photoelectron spectroscopy characterization of sulfurized tin thin films deposited by thermal evaporation. Thin Solid Films. 2018 Jan;645:409–16.
7. Kutwade V V., Gattu KP, Sonawane ME, Tonpe DA, Mishra MK, Sharma R. Contribution in PCE enhancement: numerical designing and optimization of SnS thin film solar cell. Journal of Nanoparticle Research. 2021 Jul 12;23(7):146.
8. Sanguino P, Kunst M, Ben Mbarek M, Reghima M, Bundaleski N, Teodoro O, et al. A contactless method to study carrier kinetics in SnS thin films. Vacuum. 2023 Mar;209:111784.
9. Andrade-Arvizu JA, Courel-Piedrahita M, Vigil-Galán O. SnS-based thin film solar cells: perspectives over the last 25 years. Journal of Materials Science: Materials in Electronics. 2015 Jul 14;26(7):4541–56.
10. Kuang H, Xiao Y. Numerical simulation of Cu₂Te based thin film solar cell with Cu₂O HTL for high efficiency. Micro and Nanostructures. 2024 Apr;188:207790.
11. HafaiFa L, Maache M, Allam Z, Zebeir A. Simulation and performance analysis of CdTe thin film solar cell using different Cd-free zinc chalcogenide-based buffer layers. Results in Optics. 2024 Feb;14:100596.
12. Oublal E, Al-Hattab M, Ait Abdelkadir A, Sahal M, Kumar N. Photovoltaic efficacy of CNGS as BSF and second absorber for CIGS thin film solar cells- numerical approach by SCAPS-1D framework. Materials Science and Engineering: B. 2024 Jul;305:117401.
13. Chouk R, Aguir C, Tala-Ighil R, Al-Hada NM, Al-Asbahi BA, Khalfaoui M. Numerical simulation and optimal design of perovskite solar cell based on sensitized zinc oxide electron-transport layer. Multiscale and Multidisciplinary Modeling, Experiments and Design. 2024 Mar 2;
14. Shamardin A, Kurbatov D, Volobuev V. Analysis of Spray Deposited Cu₂ZnSnXGe_{1-x}S₄ Thin Film Solar Cells: Model Creation in SCAPS-1D and Numerical Simulation of Their Performance. In: 2020 IEEE 10th International Conference Nanomaterials: Applications & Properties (NAP). Sumy, Ukraine: IEEE; 2020. p. 01TFC20-1-01TFC20-4.
15. Chargui T, Lmai F, AL-Hattab M, Bajjou O, Rahmani K. Experimental and numerical study of the CIGS/CdS heterojunction solar cell. Opt Mater (Amst). 2023 Jun;140:113849.
16. Garain R, Basak A, Singh UP. Study of thickness and temperature dependence on the performance of SnS based solar cell by SCAPS-1D. Mater Today Proc. 2021;39(5):1833–7.
17. Badyakar S, Das C. Numerical simulations on a-Si:H/SnS/ZnSe based solar cells. Mater Today Proc. 2022;62(8):5275–82.
18. Oublal E, Sahal M, Abdelkadir AA. New theoretical analysis of a novel hetero-junction SnS/CdS solar cell with homo-junction P–P+ in the rear face-numerical approach. Current Applied Physics. 2022 Jul;39:230–8.

19. Gohri S, Madan J, Pandey R. Impact of Glancing Angle Deposition Technique on the Performance of SnS Thin Film Solar Cell: SCAPS-1D simulation. In: 2022 IEEE International Conference of Electron Devices Society Kolkata Chapter (EDKCON). IEEE; 2022. p. 195–8.
20. Bhattacharjee P, Garain R, Basak A, Singh UP. Numerical modelling and performance evaluation of SnS based heterojunction solar cell with p+-SnS BSF layer. *Opt Quantum Electron*. 2022 Dec 22;54(12):867.
21. Kumar A, Prabu RT, Das A. Configuration analysis of SnS based solar cells for high-efficiency devices. *Opt Quantum Electron*. 2022 Aug 13;54(8):521.
22. Boubakri A, Joudri A, Koumya Y, Rajira A, Almaggoussi A, Abounadi A. An output characteristics simulation of SnS based solar cells. *Mater Today Proc*. 2022;51(6):2047–52.
23. Colinge J, Colinge C. *Physics of Semiconductor Devices*. Kluwer Academic Publishers; 2006. 1–102.
24. Size SM, LI Y, NG K. *Physics of Semiconductor Devices*. 4 ed. A John Wiley and Sons, Inc.; 2021. 1–83.
25. Benmir A, Aida MS. Analytical Modeling and Simulation of CIGS Solar Cells. *Energy Procedia*. 2013;36:618–27.
26. Acevedo-Luna A, Bernal-Correa R, Montes-Monsalve J, Morales-Acevedo A. Design of thin film solar cells based on a unified simple analytical model. *Journal of Applied Research and Technology*. 2017 Dec;15(6):599–608.
27. Botero MA, Mantilla MA, Calderon CL. Simulation of the absorber layer thickness effect on the performance of CuInSe₂ solar cells. In: 2019 IEEE 46th Photovoltaic Specialists Conference (PVSC). Chicago, IL, USA: IEEE; 2019. p. 0915–9.
28. Arsad AZ, Bahrudin MS, Arzaee NA, Rahman MNA, Chau CF, Abdullah SF, et al. Zinc sulfide thin films deposited by chemical bath: Tuning consideration of structural, optical band gap, and electrical properties for CIGS solar cells application. *Ceram Int*. 2024 Apr;50(7):11776–86.
29. Ahmed MJ, Saleh AN. Influence of bulk defects in SnS absorber layer on optical and electrical properties of solar cell. *J Phys Conf Ser*. 2021 Dec 1;2114(1):012044.
30. Cherouana A, Labbani R. Study of CZTS and CZTSSe solar cells for buffer layers selection. *Appl Surf Sci*. 2017 Dec;424:251–5.
31. Cheraghizade M, Jamali-Sheini F, Shabani P. Annealing temperature of nanostructured SnS on the role of the absorber layer. *Mater Sci Semicond Process*. 2019 Feb;90:120–8.
32. Vallisree S, Thangavel R, Lenka TR. Theoretical investigations on enhancement of photovoltaic efficiency of nanostructured CZTS/ZnS/ZnO based solar cell device. *Journal of Materials Science: Materials in Electronics*. 2018 May 9;29(9):7262–72.
33. Minbashi M, Ghobadi A, Ehsani MH, Rezagholipour Dizaji H, Memarian N. Simulation of high efficiency SnS-based solar cells with SCAPS. *Solar Energy*. 2018 Dec;176:520–5.
34. Jafarzadeh F, Aghili H, Nikbakht H, Javadpour S. Design and optimization of highly efficient perovskite/homojunction SnS tandem solar cells using SCAPS-1D. *Solar Energy*. 2022 Apr;236:195–205.
35. Ahmmed S, Aktar A, Hossain J, Ismail ABMd. Enhancing the open circuit voltage of the SnS based heterojunction solar cell using NiO HTL. *Solar Energy*. 2020 Sep;207:693–702.
36. Echendu OK, Weerasinghe AR, Diso DG, Fauzi F, Dharmadasa IM. Characterization of n-Type and p-Type ZnS Thin Layers Grown by an Electrochemical Method. *J Electron Mater*. 2013 Apr 24;42(4):692–700.
37. Lin S, Li X, Pan H, Chen H, Li X, Li Y, et al. Numerical analysis of SnS homojunction solar cell. *Superlattices Microstruct*. 2016 Mar;91:375–82.